

Pavan Guru - DC Electrical Upgrade

Pavan Guru is a Leopard 44 that has been retrofitted with LiFePO4 battery, Inverter, and solar systems. The goal is to make the boat completely power independent.

Battery Compartment

12V 176Ah x 4
LiFePO4 Battery with BMS
Charge and Load Outputs



Switch Panel



— VE.Direct
— VE.Bus



Port Cabin

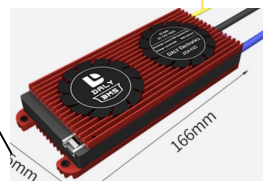
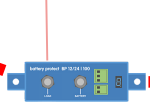
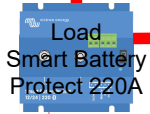
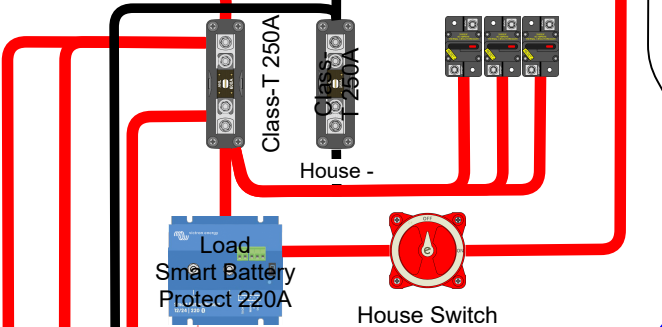

Other Areas

Northern Lights 5kW

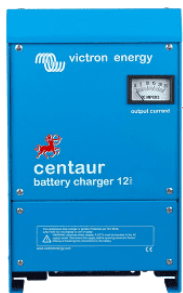
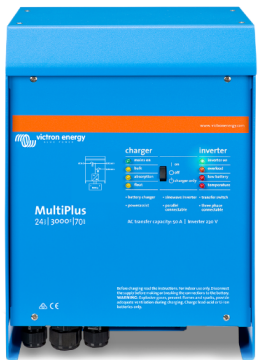
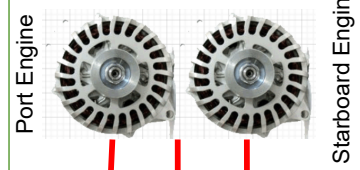

Solar Panels
2 Arrays of 2 x445w

